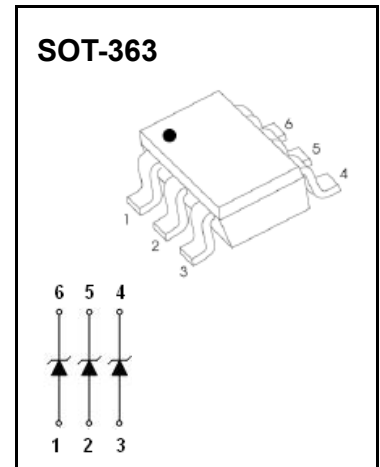

**SOT-363 Plastic-Encapsulate Diodes****BZX84C2V4TS-BZX84C39TS** ZENER DIODE**FEATURES**

- Planar Die Construction
- 200mW Power Dissipation
- Zener Voltages from 2.4V - 39V
- Three isolated diode elements in single Ultra-Small Surface Mount Package

**Maximum Ratings( $T_a=25^{\circ}\text{C}$  unless otherwise specified)**

Characteristic	Symbol	Value	Unit
Forward Voltage @ $I_F = 10\text{mA}$	$V_F$	0.9	V
Power Dissipation(Note 1)	$P_D$	200	mW
Thermal Resistance from Junction to Ambient (Note 1)	$R_{\theta JA}$	625	$^{\circ}\text{C}/\text{W}$
Operation Junction and Storage Temperature Range	$T_J, T_{stg}$	-55 ~ +150	$^{\circ}\text{C}$

# ELECTRICAL CHARACTERISTICS

$T_a=25^{\circ}\text{C}$  unless otherwise specified

Type Number	Type Code	Zener Voltage Range (Note 2)				Maximum Zener Impedance (Note 3)			Maximum Reverse Current (Note 2)		Typical Temperature Coefficient @ $I_{ZTC}$ mV/ $^{\circ}\text{C}$		Test Current $I_{ZTC}$ mA
		$V_Z@I_{ZT}$			$I_{ZT}$	$Z_{ZT}@I_{ZT}$	$Z_{ZK}@I_{ZK}$	$I_{ZK}$	$I_R$	$V_R$	Min	Max	
		Nom(V)	Min(V)	Max(V)	mA	$\Omega$		mA	$\mu\text{A}$	V			
BZX84C2V4TS	KRB	2.4	2.2	2.6	5	100	600	0.5	50	1.0	-3.5	0	5
BZX84C2V7TS	KRC	2.7	2.5	2.9	5	100	600	1.0	20	1.0	-3.5	0	5
BZX84C3V0TS	KRD	3.0	2.8	3.2	5	95	600	1.0	10	1.0	-3.5	0	5
BZX84C3V3TS	KRE	3.3	3.1	3.5	5	95	600	1.0	5	1.0	-3.5	0	5
BZX84C3V6TS	KRF	3.6	3.4	3.8	5	90	600	1.0	5	1.0	-3.5	0	5
BZX84C3V9TS	KRG	3.9	3.7	4.1	5	90	600	1.0	3	1.0	-3.5	0	5
BZX84C4V3TS	KRH	4.3	4.0	4.6	5	90	600	1.0	3	1.0	-3.5	0	5
BZX84C4V7TS	KR1	4.7	4.4	5.0	5	80	500	1.0	3	2.0	-3.5	0.2	5
BZX84C5V1TS	KR2	5.1	4.8	5.4	5	60	480	1.0	2	2.0	-2.7	1.2	5
BZX84C5V6TS	KR3	5.6	5.2	6.0	5	40	400	1.0	1	2.0	-2.0	2.5	5
BZX84C6V2TS	KR4	6.2	5.8	6.6	5	10	150	1.0	3	4.0	0.4	3.7	5
BZX84C6V8TS	KR5	6.8	6.4	7.2	5	15	80	1.0	2	4.0	1.2	4.5	5
BZX84C7V5TS	KR6	7.5	7.0	7.9	5	15	80	1.0	1	5.0	2.5	5.3	5
BZX84C8V2TS	KR7	8.2	7.7	8.7	5	15	80	1.0	0.7	5.0	3.2	6.2	5
BZX84C9V1TS	KR8	9.1	8.5	9.6	5	15	100	1.0	0.5	6.0	3.8	7.0	5
BZX84C10TS	KR9	10	9.4	10.6	5	20	150	1.0	0.2	7.0	4.5	8.0	5
BZX84C11TS	KP1	11	10.4	11.6	5	20	150	1.0	0.1	8.0	5.4	9.0	5
BZX84C12TS	KP2	12	11.4	12.7	5	25	150	1.0	0.1	8.0	6.0	10.0	5
BZX84C13TS	KP3	13	12.4	14.1	5	30	170	1.0	0.1	8.0	7.0	11.0	5
BZX84C15TS	KP4	15	13.8	15.6	5	30	200	1.0	0.1	10.5	9.2	13.0	5
BZX84C16TS	KP5	16	15.3	17.1	5	40	200	1.0	0.1	11.2	10.4	14.0	5
BZX84C18TS	KP6	18	16.8	19.1	5	45	225	1.0	0.1	12.6	12.4	16.0	5
BZX84C20TS	KP7	20	18.8	21.2	5	55	225	1.0	0.1	14.0	14.4	18.0	5
BZX84C22TS	KP8	22	20.8	23.3	5	55	250	1.0	0.1	15.4	16.4	20.0	5
BZX84C24TS	KP9	24	22.8	25.6	5	70	250	1.0	0.1	16.8	18.4	22.0	5
BZX84C27TS	KPA	27	25.1	28.9	2	80	300	0.5	0.1	18.9	21.4	25.3	5
BZX84C30TS	KPB	30	28.0	32.0	2	80	300	0.5	0.1	21.0	24.4	29.4	5
BZX84C33TS	KPC	33	31.0	35.0	2	80	325	0.5	0.1	23.1	27.4	33.4	5
BZX84C36TS	KPD	36	34.0	38.0	2	90	350	0.5	0.1	25.2	30.4	37.4	5
BZX84C39TS	KPE	39	37.0	41.0	2	130	350	0.5	0.1	27.3	33.4	41.2	5

- Notes: 1. Valid provided that device terminals are kept at ambient temperature.  
 2. Short duration pulse test used to minimize self-heating effect.  
 3.  $f = 1\text{kHz}$ .

# Typical Characteristics

Zener Characteristics ( $V_z$  Up to 10 V)

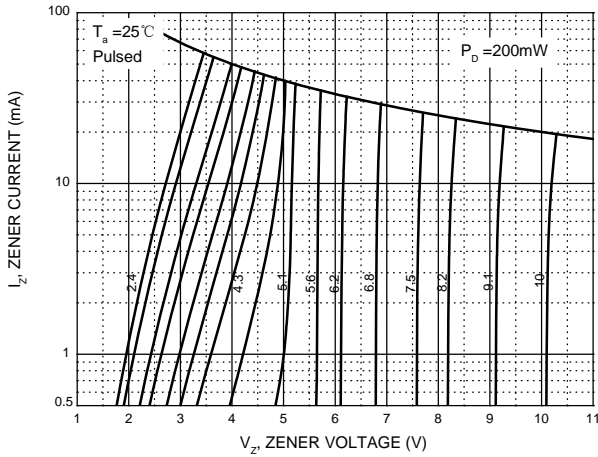

Zener Characteristics (11 V to 39 V)

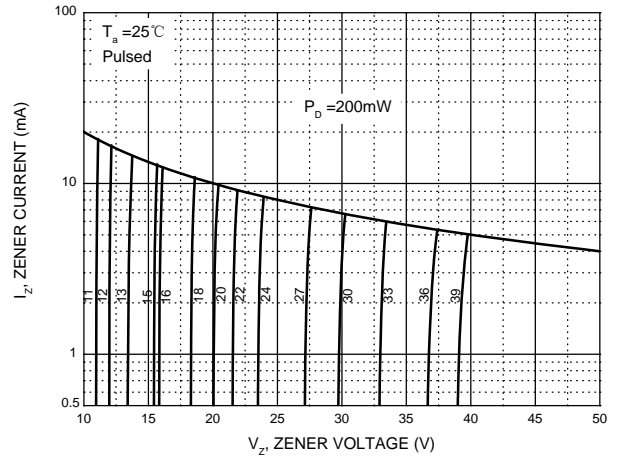

Temperature Coefficients

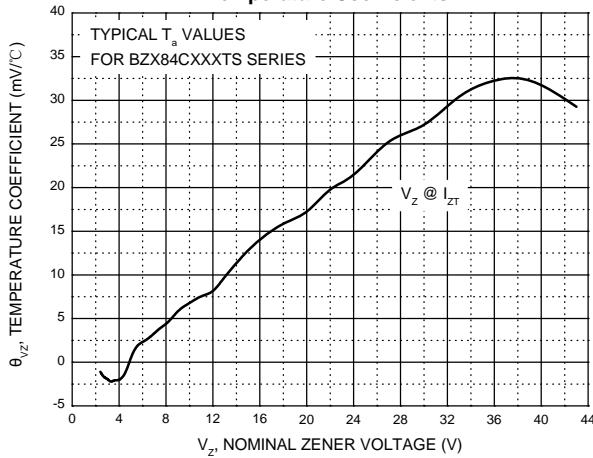

Typical Leakage Current

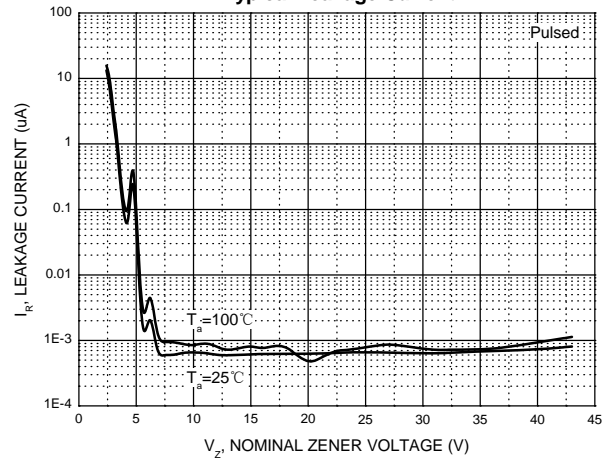

Typical Capacitance

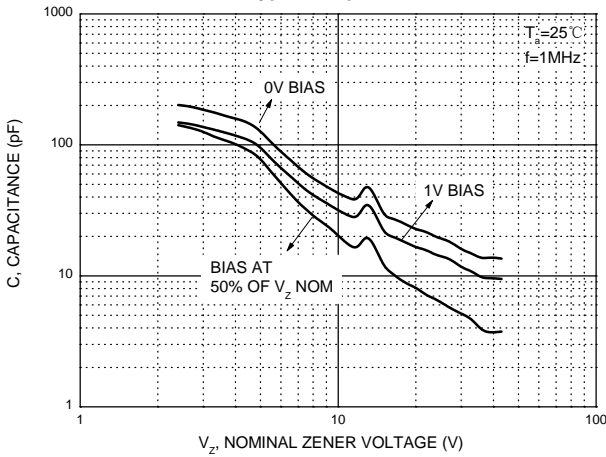

Effect of Zener Voltage on Zener Impedance

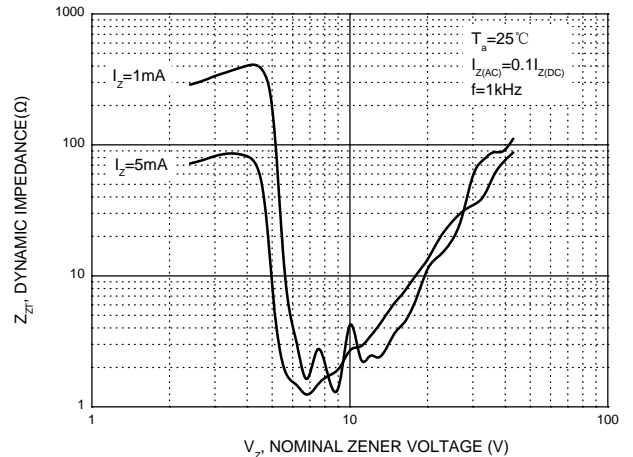

Power Derating Curve

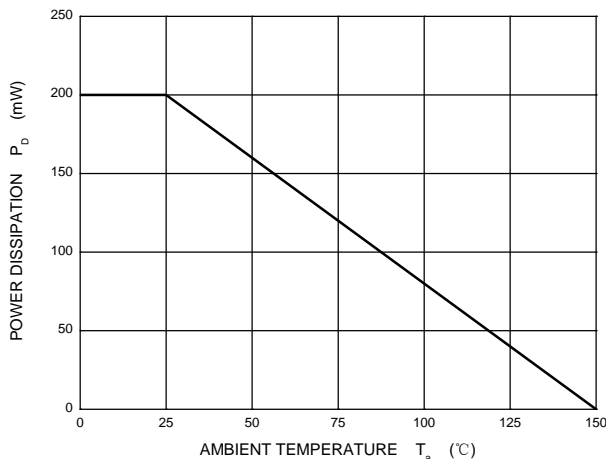

## SOT-363 Package Outline Dimensions

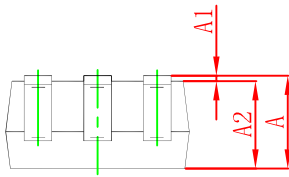
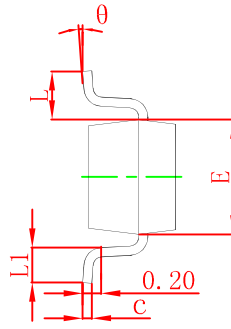
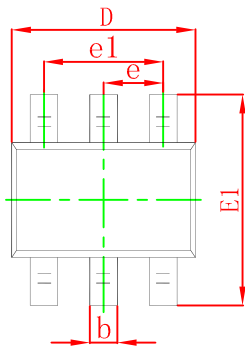

Symbol	Dimensions In Millimeters		Dimensions In Inches	
	Min	Max	Min	Max
A	0.900	1.100	0.035	0.043
A1	0.000	0.100	0.000	0.004
A2	0.900	1.000	0.035	0.039
b	0.150	0.350	0.006	0.014
c	0.100	0.150	0.004	0.006
D	2.000	2.200	0.079	0.087
E	1.150	1.350	0.045	0.053
E1	2.150	2.400	0.085	0.094
e	0.650 TYP		0.026 TYP	
e1	1.200	1.400	0.047	0.055
L	0.525 REF		0.021 REF	
L1	0.260	0.460	0.010	0.018
theta	0°	8°	0°	8°

## SOT-363 Suggested Pad Layout

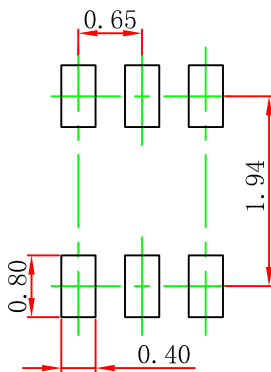

Note:

1. Controlling dimension: in millimeters.
2. General tolerance:  $\pm 0.05\text{mm}$ .
3. The pad layout is for reference purposes only.

### NOTICE

JSCJ reserves the right to make modifications, enhancements, improvements, corrections or other changes without further notice to any product herein. JSCJ does not assume any liability arising out of the application or use of any product described herein.

# SOT-363 Tape and Reel

## SOT-363 Embossed Carrier Tape

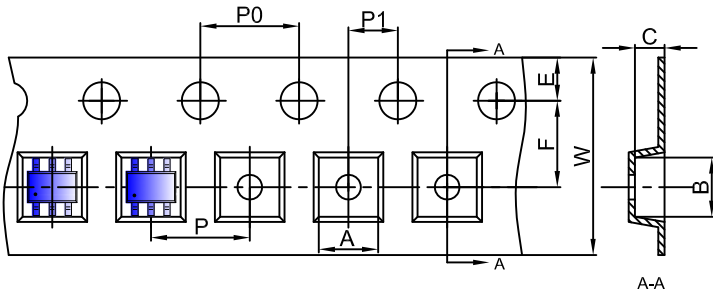

### Packaging Description:

SOT-363 parts are shipped in tape. The carrier tape is made from a dissipative (carbon filled) polycarbonate resin. The cover tape is a multilayer film (Heat Activated Adhesive in nature) primarily composed of polyester film, adhesive layer, sealant, and anti-static sprayed agent. These reeled parts in standard option are shipped with 3,000 units per 7" or 17.8cm diameter reel. The reels are clear in color and is made of polystyrene plastic (anti-static coated).

Dimensions are in millimeter										
Pkg type	A	B	C	d	E	F	P0	P	P1	W
SOT-363	2.25	2.55	1.20	Ø1.50	1.75	3.50	4.00	4.00	2.00	8.00

## SOT-363 Tape Leader and Trailer

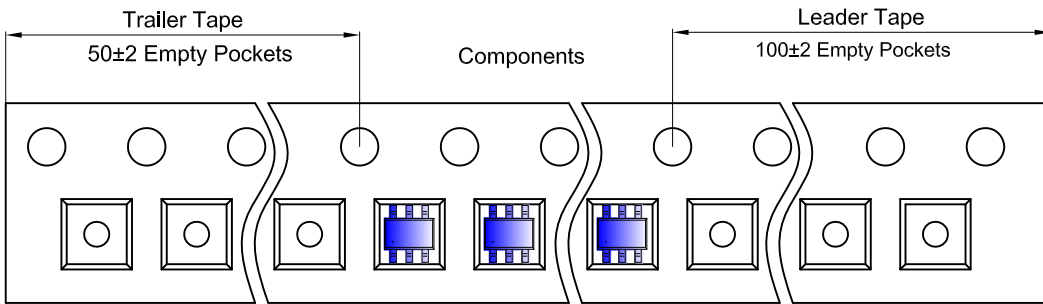

## SOT-363 Reel

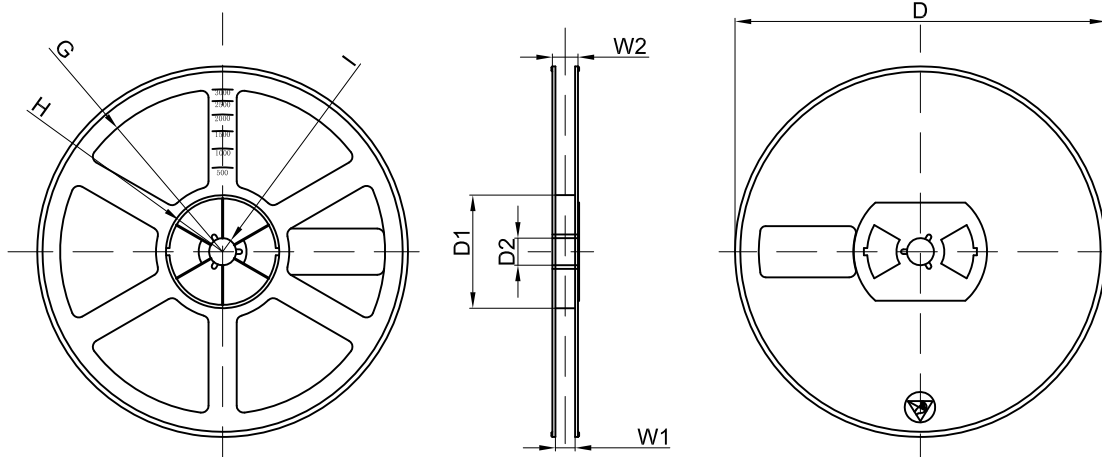

Dimensions are in millimeter								
Reel Option	D	D1	D2	G	H	I	W1	W2
7" Dia	Ø178.00	54.40	13.00	R78.00	R25.60	R6.50	9.50	12.30

REEL	Reel Size	Box	Box Size(mm)	Carton	Carton Size(mm)	G.W.(kg)
3000 pcs	7 inch	45,000 pcs	203×203×195	180,000 pcs	438×438×220	